

Article number: 204080M1029A3X

Description: E+G levelling foot

GN 40-80-M10-29-A3-X

Note: X With female thread, External hexagon

Measures

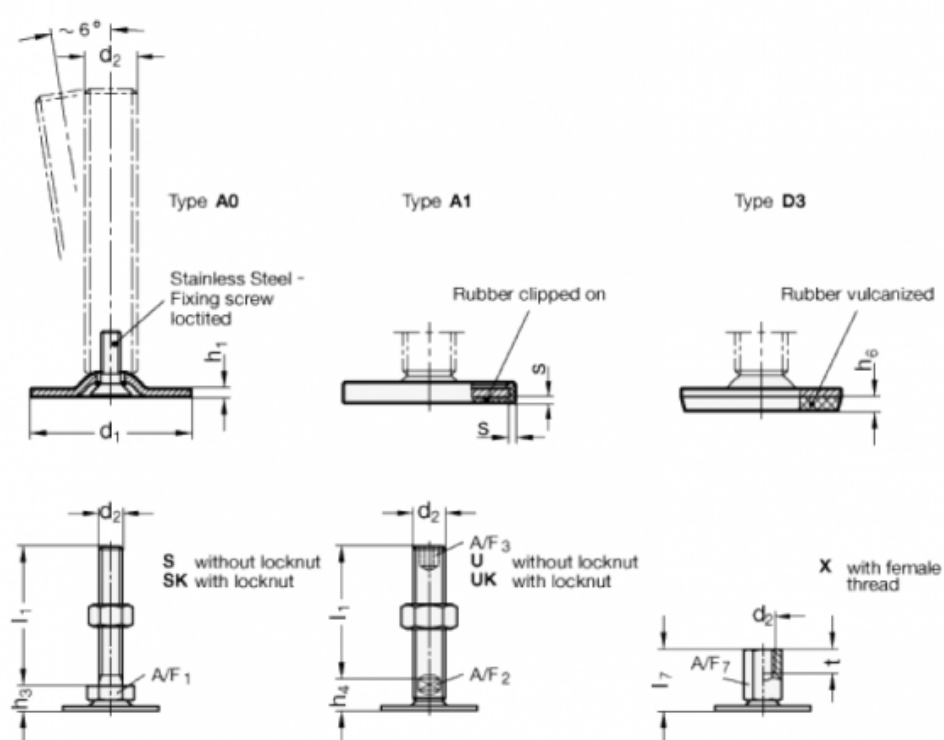

A/F7	= 14
d1	= 80
d2	= M10
h1	= 3
h6	= 5
l7	= 29
s	=
t	= 10